



		kW	PS	CC	Cyl							
Accent (X-3)	1.3	55	75	1341	4	10.94 - 08.99	58160	57160	83001	39125	53835	54781
Accent (X-3)	1.3	55	75	1341	4	09.99 - 01.00	58195	57195	83506	39086	43002	54723
Accent (X-3)	1.3	55	75	1341	4	09.99 - 01.00	58195	57195	83506	39086	43003	54723
Accent (X-3)	1.3 12V	62	84	1341	4	10.94 - 08.99	58160	57160	83001	39125	53835	54781
Accent (X-3)	1.3 12V	62	84	1341	4	09.99 - 01.00	58195	57195	83506	39086	43002	54723
Accent (X-3)	1.3 12V	62	84	1341	4	09.99 - 01.00	58195	57195	83506	39086	43003	54723
Accent (X-3)	1.5 12V	65	88	1495	4	10.94 - 08.99	58160	57160	83001	39125	53835	54781
Accent (X-3)	1.5 12V	65	88	1495	4	09.99 - 01.00	58195	57195	83506	39086	43002	54723
Accent (X-3)	1.5 12V	65	88	1495	4	09.99 - 01.00	58195	57195	83506	39086	43003	54723
Accent (X-3)	1.5 16V	73	99	1495	4	12.95 - 08.99	58160	57160	83001	39125	53835	54781
Accent (X-3)	1.5 16V	73	99	1495	4	09.99 - 01.00	58195	57195	83506	39086	43002	54723
Accent (X-3)	1.5 16V	73	99	1495	4	09.99 - 01.00	58195	57195	83506	39086	43003	54723
Accent (LC)	1.6	77	105	1599	4	12.02 -	58195	57195	83506	39086	43002	54919
Accent (LC)	1.6	77	105	1599	4	12.02 -	58195	57195	83506	39086	43003	54919
Accent (MC)	1.4 GL	71	97	1399	4	11.05 -					43296	
Accent (MC)	1.6 GLS	82	112	1599	4	11.05 -					43296	
Accent (MC)	1.5 CRDi GLS	81	110	1493	4	11.05 -					43263	
Atos (MX)	1.0 i	40	54	999	4 G4HC	02.98 -	98888		83506	39086		53162
Atos (MX)	1.0 i	43	58	999	4	03.01 -	98888		83506			53162
Atos Prime (MX)	1.0 i	40	54	999	4 G4HC	08.99 -	98888		83506			53162
Atos Prime (MX)	1.0 i	43	58	999	4	03.01 -	98888		83506			53162
Atos Prime (MX)	1.1	43	59	1086	4 G4HD	06.03 -						43333
Atos Prime (MX)	1.1	46	63	1086	4 G4HG	09.05 -						43333
Coupe (RD)	1.6 i 16V	84	114	1599	4 4G61	12.96 - 06.97	58196	57181	83002			93075
Coupe (RD)	1.6 i 16V	84	114	1599	4 4G61	06.97 - 04.02	58724	77366	83002	39135		93075
Coupe (RD)	1.6 16V	85	116	1599	4	03.98 - 04.02	58724	77366	83002	39135		93075
Coupe (RD)	2.0 16V	99	135	1975	4	03.01 - 04.02	58724	77366	83002	39135	43149	93075
Coupe (RD)	2.0 16V	102	139	1975	4 G4GF	08.96 - 06.97	58196	57181	83002			93075
Coupe (RD)	2.0 16V	102	139	1975	4 G4GF	06.97 - 04.02	58724	77366	83002	39135		93075
Coupe (GK)	2.0	102	139	1975	4 G4GC-G	03.02 -	78347	77347		39089	43149	93075
Coupe (GK)	2.0 GLS	105	143	1975	4	02.03 -	78347	77347		39089	43149	93075
Coupe (GK)	2.7 V6	123	167	2656	6 G6BA-G	03.02 -	58199			39089	43149	93075
Elantra (XD)	1.6	77	105	1599	4	05.03 -			83002	39033		93075
Elantra (XD)	1.6	79	107	1599	4 G4ED-G	06.00 -	68343	67343	83002	39033	43149	93075
Elantra (XD)	1.8	97	132	1795	4	06.00 -	58175		83002	39033	43149	93075
Elantra (XD)	2.0	102	139	1975	4 G4GC-G	06.00 -	58175		83002	39033	43149	93075
Elantra (XD)	2.0	104	141	1975	4	06.00 -	58175		83002	39033	43149	93075
Elantra (XD)	2.0	105	143	1975	4	10.03 -	98808		83002	39033	43150	93075
Elantra (XD)	1.6 CRDi	85	116	1582	4 D4FB	02.06 -	98811					
Elantra (XD)	2.0 CRDi	83	113	1991	4 D4EA	04.01 -	58175		83002	39033	43149	93075



kW PS CC Cyl

Excel (X3)	1.3	55	75	1341	4	G4EH	10.94 - 01.00	58160	57160	83001	38884	53153
Excel (X3)	1.3	55	75	1341	4	G4EH	10.94 - 01.00	58160	57160	83001	38884	53835
Excel (X3)	1.3 i 12V	62	84	1341	4	G4EH	10.94 - 01.00	58160	57160	83001	38884	53153
Excel (X3)	1.3 i 12V	62	84	1341	4	G4EH	10.94 - 01.00	58160	57160	83001	38884	53835
Excel (X3)	1.5 i 12V	65	88	1495	4	G4EK	10.94 - 01.00	58160	57160	83001	38884	53153
Excel (X3)	1.5 i 12V	65	88	1495	4	G4EK	10.94 - 01.00	58160	57160	83001	38884	53835
Excel (X3)	1.5 i 16V	73	99	1495	4		12.95 - 01.00	58160	57160	83001	38884	53153
Excel (X3)	1.5 i 16V	73	99	1495	4		12.95 - 01.00	58160	57160	83001	38884	53835
Excel (LC)	1.3	55	75	1341	4	G4E-A	01.00 -	58195	57195	83580		
Excel (LC)	1.3	62	84	1341	4		08.02 -	58195	57195	83580		
Excel (LC)	1.3	63	86	1341	4	G4E-A	01.00 -	58195	57195	83580		
Excel (LC)	1.5	66	90	1495	4	G4EB	01.00 -	58195	57195	83580		
Excel (LC)	1.5	75	102	1495	4	G4EC-G	09.00 - 10.02	58195	57195	83580		
Excel (LC)	1.5	75	102	1495	4	G4EC-G	11.02 -			83580		
Excel (LC)	1.5 CRDi	60	82	1493	3	D3-EA	04.02 - 10.02	58195	57195	83580		43263
Excel (LC)	1.5 CRDi	60	82	1493	3	D3-EA	11.02 -			83580		43263
Excel (LC)	1.6	77	105	1599	4		12.02 -			83580		
Galloper I	3.0 V6	104	141	2972	6		08.91 - 07.98	58170		34993		
Galloper I	2.5 TD	62	85	2477	4		08.91 - 07.98	58170		34993		
Galloper I	2.5 TD intercooler	70	95	2477	4		08.91 - 07.98	58170		34993		
Galloper II (JK-01)	3.0 V6	104	141	2972	6	G6AT	08.98 -	58170		34993		43004
Galloper II (JK-01)	2.5 TD	65	88	2476	4		08.98 -	58170		34993		43004
Galloper II (JK-01)	2.5 TD intercooler	73	99	2476	4	D4BH	08.98 -	58170		34993		43004
Galloper II (JK-01)	2.5 TCI	77	105	2476	4		08.98 -					43004
Getz (TB)	1.0	46	63	1086	4		09.02 -	98888		83656	39086	43029
Getz (TB)	1.3	60	82	1341	4		09.02 -	58176	57176	83656	39086	43029
Getz (TB)	1.3	63	85	1341	4		09.03 -	98924		83656	39086	43029
Getz (TB)	1.6	77	106	1599	4		09.02 -	58177		83656	39086	43147
Getz (TB)	1.5 CRDi	60	82	1496	3	D3-EA	03.03 -	58178		83656		43147
H-150	2.4	84	114	2351	4	G4CS	01.97 - 03.00	58171				
H-150	2.4	90	122	2351	4	G4CS	07.93 - 03.00					
H-150	2.5 D	55	75	2477	4	D4BA, D4BX	07.93 - 12.94					
H-150	2.5 D	57	78	2477	4	D4BB	12.94 - 03.00	58170		34993		
H-150	2.5 TD	59	80	2477	4	D4BF	07.93 - 03.00	58171		34993		
H-200	2.4	82	112	2351	4	G4CS	10.97 -	58171		34993		53160
H-200	2.4 4WD	82	112	2351	4	G4CS	10.97 -	58171		34993		53160
H-200	2.5 D	57	78	2476	4	D4BB	10.97 -					53160
H-200	2.5 TD	59	80	2476	4	D4BF	10.97 -	58170		34993		53160
H-200	2.5 TD	73	99	2476	4	D4BH	10.99 - 11.01					53160



		kW PS CC Cyl												
H-200	2.5 TD	74	101	2476	4	11.01 -						53160		
i30	1.4	80	109	1396	4	10.07 -		98810				93909		
i30	1.6	90	122	1591	4	10.07 -		98810				93909		
i30	2.0	105	143	1975	4	10.07 -		98808				93909		
i30	1.6 CRDi	85	116	1582	4	10.07 -		98811				93909		
i30	2.0 CRDi	103	140	1991	4	10.07 -		98809				93909		
Lantra I (J-1)						10.90 - 94		58154	57154	33635		53156	94467	
Lantra I (J-1)						94 - 11.95		58154	57154	33635		53836	94467	
Lantra II (J-2)	1.5 12V	65	88	1495	4	12.96 - 09.00		58160	57160	83002	39135	53161	54578	
Lantra II (J-2)	1.6 i	66	90	1599	4 G4GR	11.95 - 09.96		58160	57160	83002	39135	53159	54578	
Lantra II (J-2)	1.6 i	66	90	1599	4 G4GR	09.96 - 09.00		58160	57160	83002	39135	53161	54578	
Lantra II (J-2)	1.6 16V	84	114	1599	4 4G61	11.95 - 09.96		58160	57160	83002	39135	53159	54578	
Lantra II (J-2)	1.6 16V	84	114	1599	4 4G61	09.96 - 09.00		58160	57160	83002	39135	53161	54578	
Lantra II (J-2)	1.8 16V	94	128	1795	4 G4GM	11.95 - 09.96		58160	57160	83002	39135	53159	54578	
Lantra II (J-2)	1.8 16V	94	128	1795	4 G4GM	09.96 - 09.00		58160	57160	83002	39135	53161	54578	
Lantra II (J-2)	2.0 16V	102	139	1975	4 G4GF	08.96 - 09.00		58160	57160	83002	39135	53161	54578	
Lantra II (J-2)	1.9 D	50	68	1905	4	03.98 - 09.00		58160	57160	83002	39135	53161	54578	
Matrix (FC)	1.6	76	103	1599	4 G4ED-G	06.01 -		68343	67343		39089	43148	93870	
Matrix (FC)	1.8	90	122	1795	4 G4GB-G	06.01 -		78347	77347		39089	43148	93870	
Matrix (FC)	1.5 CRDi	60	82	1496	3 D3-EA	10.01 -		58178	57178		39089	43326	93870	
Pony (X-3)	1.3	55	75	1341	4	10.94 - 08.99		58160	57160	83001	39125	53835	54781	94467
Pony (X-3)	1.3	55	75	1341	4	09.99 - 01.00		58195	57195		39086	43002	54723	94467
Pony (X-3)	1.3	55	75	1341	4	09.99 - 01.00		58195	57195		39086	43003	54723	94467
Pony (X-3)	1.3 I 12V	62	84	1341	4	10.94 - 08.99		58160	57160	83001	39125	53835	54781	94467
Pony (X-3)	1.3 I 12V	62	84	1341	4	09.99 - 01.00		58195	57195		39086	43002	54723	94467
Pony (X-3)	1.3 I 12V	62	84	1341	4	09.99 - 01.00		58195	57195		39086	43003	54723	94467
Pony (X-3)	1.5 I 12V	65	88	1495	4	10.94 - 08.99		58160	57160	83001	39125	53835	54781	94467
Pony (X-3)	1.5 I 12V	65	88	1495	4	09.99 - 01.00		58195	57195		39086	43002	54723	94467
Pony (X-3)	1.5 I 12V	65	88	1495	4	09.99 - 01.00		58195	57195		39086	43003	54723	94467
Pony (X-3)	1.5 I 16V	73	99	1495	4	12.95 - 08.99		58160	57160	83001	39125	53835	54781	94467
Pony (X-3)	1.5 I 16V	73	99	1495	4	09.99 - 01.00		58195	57195		39086	43002	54723	94467
Pony (X-3)	1.5 I 16V	73	99	1495	4	09.99 - 01.00		58195	57195		39086	43003	54723	94467
Santa Fé (SM)	2.0	99	135	1997	4 G4BP	08.01 - 02.04		68800	67800	83580	39087	43005	93866	
Santa Fé (SM)	2.0	99	135	1997	4 G4BP	03.04 -		68800	67800	83580	39087	43180		
Santa Fé (SM)	2.4 16V	100	136	2351	4 G4JS-G	02.01 - 02.04		68800	67800	83580	39087	43005	93866	
Santa Fé (SM)	2.4 16V	100	136	2351	4 G4JS-G	03.04 -		68800	67800	83580	39087	43180		
Santa Fé (SM)	2.4 16V 4x4	100	136	2351	4 G4JS-G	02.01 - 02.04		68800	67800	83580	39087	43005	93866	
Santa Fé (SM)	2.4 16V 4x4	100	136	2351	4 G4JS-G	03.04 -		68800	67800	83580	39087	43180		
Santa Fé (SM)	2.4 16V	107	146	2351	4 G4JS-G	02.01 - 02.04		68800	67800	83580	39087	43005	93866	



kW PS CC Cyl

Santa Fé (SM)	2.4 16V	107	146	2351	4	G4JS-G	03.04 -	68800	67800	83580	39087	43180		
Santa Fé (SM)	2.4 16V 4x4	107	146	2351	4	G4JS-G	02.01 - 02.04	68800	67800	83580	39087	43005	93866	
Santa Fé (SM)	2.4 16V 4x4	107	146	2351	4	G4JS-G	03.04 -	68800	67800	83580	39087	43180		
Santa Fé (SM)	2.7 V6 4x4	127	173	2656	6	G6BA-G	02.01 - 02.04	68802	67802	83580	39087	43005	93866	
Santa Fé (SM)	2.7 V6 4x4	127	173	2656	6	G6BA-G	03.04 -	68802	67802	83580	39087	43180		
Santa Fé (SM)	2.0 CRDi	83	113	1991	4	D4EA	08.01 - 02.04	68802	67802	83580	39087	43005	93866	
Santa Fé (SM)	2.0 CRDi	83	113	1991	4	D4EA	03.04 -	68802	67802	83580	39087	43180		
Santa Fé (SM)	2.0 CRDi 4x4	83	113	1991	4	D4EA	02.01 - 02.04	68802	67802	83580	39087	43005	93866	
Santa Fé (SM)	2.0 CRDi 4x4	83	113	1991	4	D4EA	03.04 -	68802	67802	83580	39087	43180		
Santa Fé (CM)	2.7	125	170	2657	6		03.06 -				39087			
Santa Fé (CM)	2.7 4x4	125	170	2657	6		03.06 -				39087			
Santa Fé (CM)	2.7 V6 GLS	139	189	2656	6		03.06 -				39087			
Santa Fé (CM)	2.7 V6 GLS 4x4	139	189	2656	6		03.06 -				39087			
Santa Fé (CM)	2.2 CRDi	102	139	2188	4		03.06 -	98807			39087			
Santa Fé (CM)	2.2 CRDi 4x4	102	139	2188	4		03.06 -	98807			39087			
Santa Fé (CM)	2.2 CRDi GLS	110	150	2188	4		03.06 -	98807			39087			
Santa Fé (CM)	2.2 CRDi GLS 4x4	110	150	2188	4		03.06 -	98807			39087			
Santa Fé (CM)	2.2 CRDi	114	155	2188	4		03.06 -	98807			39087			
Santa Fé (CM)	2.2 CRDi 4x4	114	155	2188	4		03.06 -	98807			39087			
Santamo	2.0 16V	102	139	1997	4		05.99 -	58154	57154	34978		43006	93850	
Santamo	2.0 16V 4x4	102	139	1997	4		05.99 -	58154	57154	34978		43006	93850	
Satellite (KM)	2.4	82	112	2351	4	G4CS	10.97 -	58171				53160		
Satellite (KM)	2.4 4WD	82	112	2351	4	G4CS	10.97 -	58171				53160		
Satellite (KM)	2.5 D	57	78	2476	4	D4BB	10.97 -					53160		
Satellite (KM)	2.5 TD	59	80	2476	4	D4BF	10.97 -	58170		34993		53160		
Satellite (KM)	2.5 TD	73	99	2476	4	D4BH	10.99 - 11.01					53160		
Satellite (KM)	2.5 TD	74	101	2476	4		11.01 -					53160		
S-coupe (SLC)	1.5 i						02.90 - 06.93		57560	33650		53152	54662	94467
S-coupe (SLC)	1.5 i						06.93 - 05.96			83002		43007		94467
Sonata I (Y2)	2.0 i	74	101	1997	4		09.88 - 08.91			33637		53158	54717	94468
Sonata I (Y2)	2.0 i	80	109	1997	4	G4CP-U	01.91 - 10.93			33636		53154	54717	94468
Sonata I (Y2)	2.0 i 16V	96	130	1997	4	G4CP-D	01.91 - 10.93			33636		53154	54717	94468
Sonata I (Y2)	2.4 i	83	113	2351	4		09.88 - 08.91			33637		53158	54717	94468
Sonata I (Y2)	3.0 i V6	107	145	2972	6	G6AT	01.91 - 10.93			33636		53154	54717	94468
Sonata II (Y3)	1.8 i	72	98	1796	4		05.93 - 06.98			83507		53837	54584	94468
Sonata II (Y3)	2.0 i	70	95	1997	4		08.96 - 06.98	58154	57154	83507		53837	54584	94468
Sonata II (Y3)	2.0 i	77	105	1997	4	G4CP	06.94 - 08.96	58154	57154	83507		53837	54584	94468
Sonata II (Y3)	2.0 i 16V	92	125	1997	4	G4CP-DM	06.96 - 06.98	58154	57154	83507		53837	54584	94468
Sonata II (Y3)	2.0 i 16V	102	139	1997	4	G4CP-D	05.93 - 06.98	58154	57154	83507		53837	54584	94468



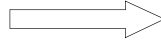

		kW PS CC Cyl									
Sonata II (Y3)	3.0 i V6	107	146	2972	6	G6AT	05.93 - 06.98		83507	53837	94468
Sonata III (EF)	2.0 16V	100	136	1997	4	G4JP-G	06.98 - 10.01	68800	67800	83062	43008
Sonata III (EF)	2.5 V6 24V	118	160	2493	6	G6BV-G	06.98 - 10.01	58185		83062	39088
Sonata III (EF)	2.4 16V	105	143	2351	4		03.98 - 10.01	68800	67800	83062	39088
Sonata IV	2.0	96	131	1997	4	G4JP-EG	10.01 -	68800	67800	83653	43008
Sonata IV	2.7 V6	127	173	2656	6	G6BA-G	10.01 -	58185		83653	43008
Sonata V	2.4	119	162	2359	4		01.05 -				43302
Sonata V	3.3	171	233	3342	6		01.05 -				43302
Sonata V	2.0 CRDi	100	136	1991	4		02.06 -				43302
Sonata V	2.0 CRDi	103	140	1991	4		02.06 -				43302
Starex (H1)	2.4	82	112	2351	4		06.97 -	58171		34993	53160
Starex (H1)	2.4 4WD	82	112	2351	4		02.98 -	58171		34993	53160
Starex (H1)	2.5 TD	59	80	2476	4		06.97 -	58170		34993	53160
Starex (H1)	2.5 TD 4WD	59	80	2476	4		02.98 -	58170		34993	53160
Terracan (HP)	3.5 i V6 4WD	147	200	3497	6		12.01 -			34977	
Terracan (HP)	2.5 TD	74	101	2476	4		12.01 -			34977	
Terracan (HP)	2.9 CRDi	110	150	2902	4		12.01 -	98881	97881	34977	43071
Terracan (HP)	2.9 CRDi	120	163	2902	4		11.03 -	98881	97881	34977	43071
Trajet (FO)	2.0	100	136	1997	4	G4JP-G	03.00 -	68800	67800	83580	39088
Trajet (FO)	2.0	103	140	1975	4		01.04 -			83580	43009
Trajet (FO)	2.7 V6	127	173	2656	6		09.00 -	68802	67802	83580	43009
Trajet (FO)	2.0 CRDi	83	113	1991	4	D4EA	04.01- 08.02	68802	67802	83580	39088
Trajet (FO)	2.0 CRDi	83	113	1991	4	D4EA	08.02 -	98851		83580	39088
Tucson (JM)	2.0	104	141	1975	4		08.04 -	98373		39190	43204
Tucson (JM)	2.0 4 X 4	104	141	1975	4		08.04 -	98373		39190	43204
Tucson (JM)	2.7 4 X 4	129	175	2656	6		08.04 -	98374		39190	43204
Tucson (JM)	2.0 CRDi	83	113	1991	4	D4EA	08.04 -	98847		39190	43204
Tucson (JM)	2.0 CRDi 4 X 4	83	113	1991	4	D4EA	08.04 -	98847		39190	
Tucson (JM)	2.0 CRDi	103	140	1991	4		01.06 -			39190	
Tucson (JM)	2.0 CRDi 4 X 4	103	140	1991	4		01.06 -			39190	
XG	25	120	163	2493	6		12.98 -	68802	67802	83653	93912
XG	30/300	138	188	2972	6	G6CT-G	12.98 -	58197		83653	39088
XG	350	145	197	3497	6		04.03 -	58197		83653	39088



4 SEASONS	Page	4 SEASONS	Page	4 SEASONS	Page	4 SEASONS	Page	4 SEASONS	Page	4 SEASONS	Page	4 SEASONS	Page	4 SEASONS	Page	4 SEASONS	Page	4 SEASONS	Page
33635	238	53160	235	83001	238														
33636	238	53161	235	83002	238														
33637	238	53162	235	83062	238														
33650	238	53835	236	83506	239														
34977	238	53836	236	83507	239														
34978	238	53837	236	83580	239														
34993	238	54578	236	83653	239														
38884	239	54584	236	83656	239														
39033	239	54662	236	93075	237														
39086	239	54717	236	93083	237														
39087	239	54723	236	93850	237														
39088	239	54781	236	93866	237														
39089	239	54919	237	93870	237														
39125	239	57154	229	93909	237														
39135	239	57160	229	93912	237														
39190	239	57176	229	94467	237														
43002	232	57178	229	94468	238														
43003	232	57181	230	97881	232														
43004	232	57195	230	98373	231														
43005	233	57560	232	98374	231														
43006	233	58154	229	98807	231														
43007	233	58160	229	98808	231														
43008	233	58170	229	98809	231														
43009	233	58171	229	98810	231														
43029	233	58175	229	98811	231														
43071	233	58176	229	98847	231														
43147	233	58177	229	98851	231														
43148	233	58178	229	98881	232														
43149	234	58185	229	98888	232														
43150	234	58195	230	98924	232														
43180	234	58196	230																
43204	234	58197	230																
43263	234	58199	230																
43296	234	58724	230																
43302	234	67343	230																
43326	234	67800	230																
43333	234	67802	230																
53152	235	68343	230																
53153	235	68800	230																
53154	235	68802	230																
53156	235	77347	230																
53158	235	77366	230																
53159	235	78347	230																

4 SEASONS

NEW: 58154
RMFG: 57154

47877

Ø 140 mm
Poly-V4
200 cc
Ford FS10

97701-34A80 / 97701-34081 / 97701-34001

4 SEASONS

NEW: 58160
RMFG: 57160



Ø 129 mm
Poly-V4
150 cc
Halla HS-15
VVVAA-03

97701-22261 / 97701-29510 / 97701-24800 / VVVAA-03

4 SEASONS

NEW: 58170
RMFG: [REDACTED]



Ø 142 mm
1 G - A
190 cc
Halla HS-18

97701-4A151

4 SEASONS

NEW: 58171
RMFG: [REDACTED]



Ø 137 mm
1 G - A
190 cc
Halla HS-18

97701-41370 / 97701-4A300 / 97701-4A370 / 97701-4A750

4 SEASONS

NEW: 58175
RMFG: [REDACTED]



Ø 128 mm
Poly-V4
150 cc
Halla HS-15

97701-2D100

4 SEASONS

NEW: 58176
RMFG: 57176



Ø 128 mm
Poly-V4
150 cc
Halla HS-15

97701-1C150

4 SEASONS

NEW: 58177
RMFG: [REDACTED]



Ø 138 mm
Poly-V4
150 cc
Halla HS-15

97701-1C250

4 SEASONS

NEW: 58178
RMFG: 57178



Ø 128 mm
Poly-V6
150 cc
Halla HS-15
DEYDA02

97701-17800

4 SEASONS

NEW: 58185
RMFG: [REDACTED]



Ø 128 mm
Poly-V6
225 cc
HCC HS-18

9770138170 / 97701-38171

Non contractual pictures / photos non contractuelles / nicht vertragliche Fotos / fotografie non contrattuali / fotos no contractuales



4 SEASONS

NEW: **58195**
RMFG: **57195**



∅ 128 mm
Poly-V4
150 cc
Halla HS-15
QCVBA02

97701-25000

4 SEASONS

NEW: **58196**
RMFG: **57181**



∅ 138 mm
Poly-V4
200 cc
Ford FS10

97701-29000 / 97701-34071

4 SEASONS

NEW: **58197**
RMFG: **57181**



∅ 128 mm
Poly-V6
200 cc
Ford FS10

97701-39881

4 SEASONS

NEW: **58199**
RMFG: **57181**



∅ 125 mm
Poly-V6
150 cc
Halla HS-15

97701-2C600

4 SEASONS

NEW: **58724**
RMFG: **77366**



∅ 133 mm
Poly-V4
150 cc
Halla HS-15
AKS8C08

97701-27000

4 SEASONS

NEW: **68343**
RMFG: **67343**



∅ 128 mm
Poly-V4
150 cc
Halla HS-15
QCVBA02

97701-2D000 / 97701-2C000

4 SEASONS

NEW: **68800**
RMFG: **67800**



∅ 122 mm
Poly-V5
200 cc
Halla HS-18
AJUCD03

97701-26010 / 97701-26011 / 97701-38070 / 97701-38071 / BBWAB-07

4 SEASONS

NEW: **68802**
RMFG: **67802**

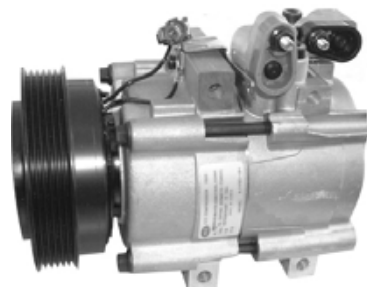

∅ 122 mm
Poly-V6
200 cc
Halla HS-18
AJUBD04

97701-26300 / 97701-26200 / 97701-39180 / 97701-39181 / 97701-3A680

4 SEASONS

NEW: **78347**
RMFG: **77347**



∅ 123 mm
Poly-V4
150 cc
Halla HS-15

97701-2C100

Non contractual pictures / photos non contractuelles / nicht vertragliche Fotos / fotografie non contractuali / fotos no contractuales

4 SEASONS

NEW: 98373
RMFG:



Ø 125 mm
Poly-V4
190 cc
Doowon 10PA15C

97701-2D700

4 SEASONS

NEW: 98374
RMFG:



Ø 120 mm
Poly-V6
190 cc
Doowon 10PA17C

97701-2E300

4 SEASONS

NEW: 98807
RMFG:



Ø 120 mm
Poly-V6
150 cc
Halla VS-16

97701-2B100 / 97701-2B101

4 SEASONS

NEW: 98808
RMFG:



Ø 125 mm
Poly-V4
150 cc
Halla VS-16

97701-2H100

4 SEASONS

NEW: 98809
RMFG:

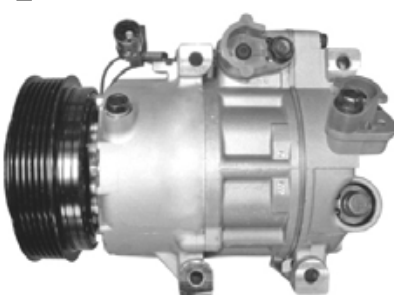

Ø 120 mm
Poly-V6
150 cc
Halla VS-16

97701-2L300 / 97701-1H300

4 SEASONS

NEW: 98810
RMFG:



Ø 128 mm
Poly-V6
150 cc
Halla VS-16

97701-2H000

4 SEASONS

NEW: 98811
RMFG:



Ø 128 mm
Poly-V4
150 cc
Halla VS-16

97701-2H200

4 SEASONS

NEW: 98847
RMFG:



Ø 120 mm
Poly-V6
200 cc
Doowon 10PA15C

97701-2D600

4 SEASONS

NEW: 98851
RMFG:



Ø 120 mm
Poly-V6
160 cc
HCC HS-18

97701-3A480 / 97701-3A481 / AJWCB-04

Non contractual pictures / photos non contractuelles / nicht vertragliche Fotos / fotografie non contrattuali / fotos no contractuales

4 SEASONS

NEW: 98881
RMFG: 97881



∅ 128 mm
Poly-V6
180 cc
HCC HS-18

97610-H1021 / ACWCA-05 / ACWCA-06

4 SEASONS

NEW: 98888
RMFG:



∅ 123 mm
Poly-V4
225 cc
HCC HS-11

97701-02000 / 97701-02200 / 97701-02300 / 97701-02310 / 97701-1C100

4 SEASONS

NEW: 98924
RMFG:

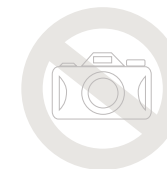

∅ mm
Poly-V
cc

97701-1C030

4 SEASONS

NEW:
RMFG: 57560



∅ 140 mm
1 G - A
135 cc
Sanden 709

4 SEASONS

4 SEASONS

4 SEASONS

43002

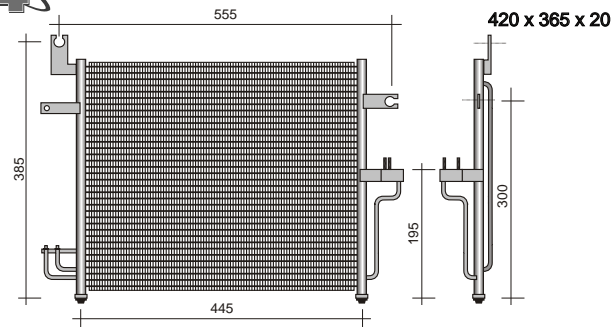

97606-25600

4 SEASONS

43003

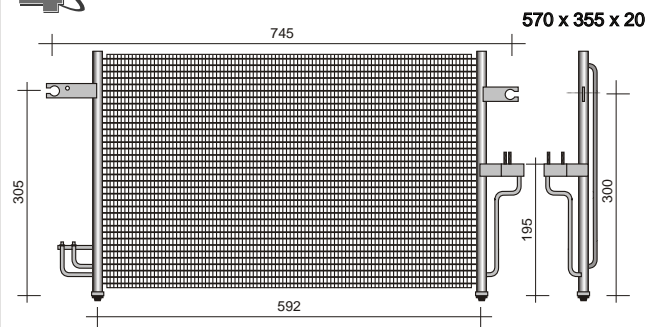

97606-25500

4 SEASONS

43004

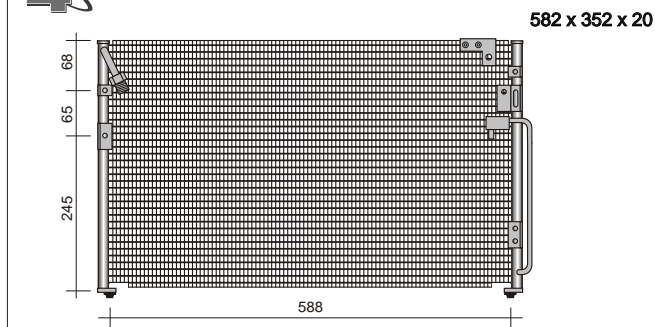

KK37161480E / HR780051

Non contractual pictures / photos non contractuelles / nicht vertragliche Fotos / fotografie non contrattuali / fotos no contractuales

4 SEASONS **43005**
630 x 345 x 20
 720
 100
 740
 97606-26000

4 SEASONS **43006**
620 x 350 x 19
 370
 325
 668
 385
 97660-M2000

4 SEASONS **43007**
520 x 330 x 25
 635
 559
 97606-23331

4 SEASONS **43008**
680 x 345 x 20
 763
 395
 170
 110
 748
 97606-38001 / 97606-38002

4 SEASONS **43009**
675 x 360 x 20
 725
 310
 97
 748
 70
 97606-3A100

4 SEASONS **43029**
503 x 350 x 18
 650
 275
 530
 275
 97606-1C000 / 97606-1C100 / 97606-1C200

4 SEASONS **43071**
580 x 385 x 17
 660
 610
 325
 97606-M1000

4 SEASONS **43147**
503 x 350 x 18
 650
 275
 530
 275
 97606-1C300 / 97606-1C350

4 SEASONS **43148**
600 x 360 x 20
 580
 105
 175
 650
 97606-17000

Non contractual pictures / photos non contractuelles / nicht vertragliche Fotos / fotografie non contrattuali / fotos no contractuales



4 SEASONS **43149**

557 x 355 x 19

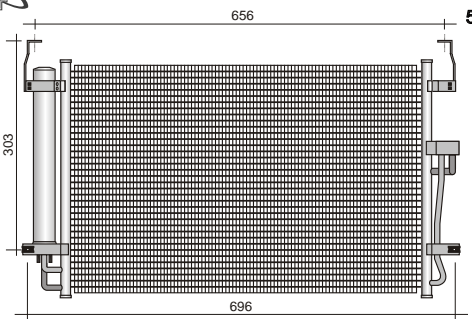

97606-2D000

4 SEASONS **43150**



97606-2D500

4 SEASONS **43180**



97606-26400

4 SEASONS **43204**

600 x 370 x 16

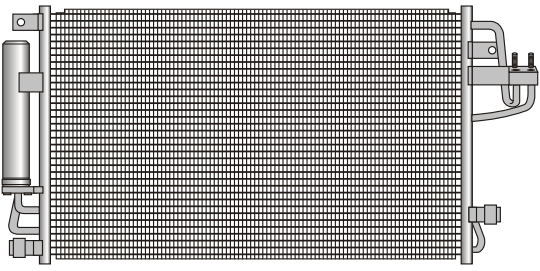

97696-2E200

4 SEASONS **43263**



97606-25800

4 SEASONS **43296**

505 x 350 x 16

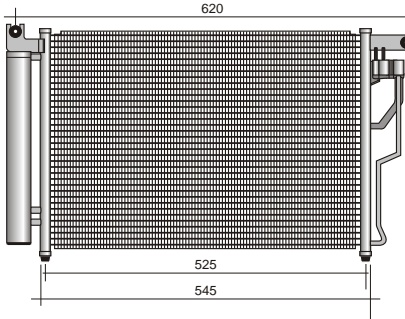

97606-1E300

4 SEASONS **43302**



97606-3K160 / 97606-3L180

4 SEASONS **43326**



97606-17800

4 SEASONS **43333**



97606-05500

Non contractual pictures / photos non contractuelles / nicht vertragliche Fotos / fotografie non contrattuali / fotos no contractuales

SEASONS **53152**
728 x 255 x 16

97606-24010

SEASONS **53153**
595 x 395 x 20

97606-24820

SEASONS **53154**
590 x 350 x 16

97606-33300

SEASONS **53156**
580 x 320 x 25

97606-28000 / 97606-28001

SEASONS **53158**
622 x 381 x 25

97606-33002

SEASONS **53159**
605 x 350 x 16

97606-29000

SEASONS **53160**
588 x 394 x 22

97606-4A000 / 97606-4A250 / 97606-4A251

SEASONS **53161**
605 x 350 x 16

97606-29100

SEASONS **53162**
405 x 342 x 17

97606-02000

Non contractual pictures / photos non contractuelles / nicht vertragliche Fotos / fotografie non contrattuali / fotos no contractuales



4 SEASONS **53835**
 530 x 324 x 18
 660
 220
 525

97606-22000 / 97606-22010 / 97606-22020 / 97606-22050 / 97606-22051

4 SEASONS **53836**
 580 x 300 x 16
 699
 187
 321
 565

97606-28042 / 97606-28051

4 SEASONS **53837**
 325 x 345 x 16
 722
 210
 595
 678

97606-34000 / 97606-34001 / 97606-34002 / 97606-34003

4 SEASONS **54578**
 216 x 235 x 86

97604-29000

4 SEASONS **54584**
 219 x 239 x 92

97027-34000

4 SEASONS **54662**
 230 x 225 x 78

97601-24001

4 SEASONS **54717**
 219 x 241 x 92

97611-33000

4 SEASONS **54723**
 216 x 235 x 92

97609-22001

4 SEASONS **54781**
 220 x 211 x 81

97609-22000

Non contractual pictures / photos non contractuelles / nicht vertragliche Fotos / fotografie non contrattuali / fotos no contractuales

4 SEASONS

54919



4 SEASONS

93075

210 x 159 x 19



4 SEASONS

93083

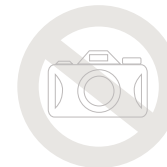

97138-2D000

97221-1C100

4 SEASONS

93850

195 x 147 x 42

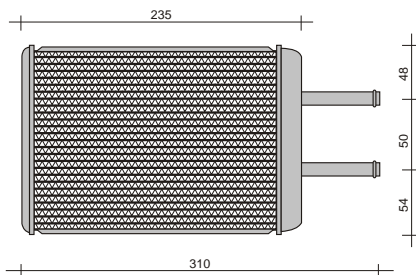

4 SEASONS

93866

210 x 170 x 28

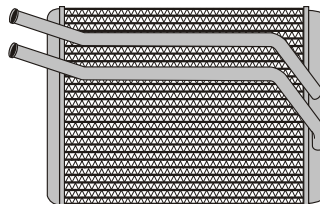

4 SEASONS

93870

212 x 152 x 22

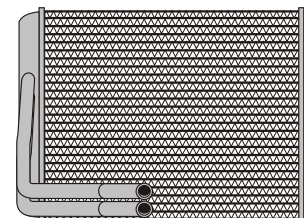

97020-M2000

97227-26000

97138-17000

4 SEASONS

93909



4 SEASONS

93912



4 SEASONS

94467

150 x 165 x 42

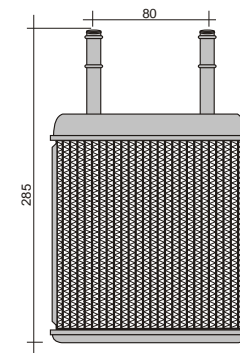

97138-2L000

97227-38000

97123-24000

Non contractual pictures / photos non contractuelles / nicht vertragliche Fotos / fotografie non contrattuali / fotos no contractuales



4 SEASONS



94468

235 x 152 x 48

4 SEASONS

4 SEASONS

97123-33000

4 SEASONS

33635



97801-28000

4 SEASONS

33636



97820-33330

4 SEASONS

33637



97820-33052

4 SEASONS

33650



97801-24000

4 SEASONS

34977



97801-H1000

4 SEASONS

34978



97850-M2000

4 SEASONS

34993



4 SEASONS

83001



97801-22000 / 97801-22001

4 SEASONS

83002



97801-29000

4 SEASONS

83062



97801-38000

Non contractual pictures / photos non contractuelles / nicht vertragliche Fotos / fotografie non contrattuali / fotos no contractuales

4 SEASONS **83506**

97801-02000

4 SEASONS **83507**

97820-34001 / 97850-34100 / 97850-34101

4 SEASONS **83580**

97802-25000

4 SEASONS **83653**

97801-38001 / 97801-38086 / 97801-38003

4 SEASONS **83656**

4 SEASONS **38884**

4 SEASONS **39033**

97262-2D100 / 97626-2D000 / 97626-2D100
/ 97626-2D400 / 97626-2D500

4 SEASONS **39086**

97604-1C050 / 97604-1C100 / 97604-25100

4 SEASONS **39087**

97604-26000 / 97604-26001

4 SEASONS **39088**

97626-38000 / 97626-38006

4 SEASONS **39089**

97604-17000 / 97604-17001

4 SEASONS **39125**

97626-22000

4 SEASONS **39135**

97626-29000 / 97626-29002

4 SEASONS **39190**

97626-2E100

Non contractual pictures / photos non contractuelles / nicht vertragliche Fotos / fotografie non contrattuali / fotos no contractuales